



# paralela

nahtrang studio



Daniel Vila and Ester Pujol, industrial designers, founders of Nahtrang Studio, Barcelona (Spain).



"Draws inspiration from the memory of the light reflections of an architectural element of our origins, a particular type of shutter typical of the Mediterranean tradition".

"Trae ispirazione dal ricordo dei riflessi di luce di un elemento architettonico delle nostre origini, un particolare tipo di persiana tipica della tradizione mediterranea".



ACTUXC30EXB1ER + ACTESTAC001XXR + ACDISTBIXORXXR + CANOPY + DRIVER

## Interview with Daniel Vila and Ester Pujol

Can you tell us a bit about what the initial inspiration was for this collection?

We were thinking about the immaterial nature of light, the way a lamp can hold light, giving it a form of its own. We were inspired by the idea of tightening the light. We like the idea of a ladder of illuminated parallel lines, ordered by gravity, connected together in a point where each lamp rests and holds the next one, developing a visual dialogue, a symphony of light.

Potete raccontarci qual è stata l'ispirazione iniziale per questa collezione?

Stavamo pensando all'immaterialità della luce, a come in un certo senso una lampada possa trattenere la luce diventando essa stessa una forma. Ci siamo ispirati all'idea di stringere la luce. Ci piace l'idea di una scala sospesa di linee parallele illuminate, ordinate per gravità, collegate tra loro in un punto dove ogni lampada poggia e sostiene quella successiva, sviluppando un dialogo visivo, una sinfonia di luce.

What is most important for you when designing lighting fixtures?

We keep in mind not only the lamp itself, but also what do we want to communicate, what kind of environment we want to generate. Illumination for us is, without any doubt, the most important element to create a pleasant atmosphere. It has the power to change moods, to modify our biorhythms... so we feel a huge responsibility designing it. Starting from there, we try to wrap all of this in the most suitable envelope.

Qual è la cosa più importante per voi quando progettate oggetti di illuminazione?

Pensiamo, non solo alla lampada in sé, ma a cosa vogliamo comunicare, a che tipo di ambiente vogliamo generare. L'illuminazione per noi è, senza alcun dubbio, l'elemento più importante per creare un'atmosfera piacevole, ha il potere di cambiare gli stati d'animo, di modificare i nostri bioritmi... quindi sentiamo una grande responsabilità nel progettare. Da qui, cerchiamo di incastolare tutto questo nella busta più adatta.

What inspires your work?

An exhibition, a song, a book or a trip, light, tranquility and keeping the mind awake... all of this works for us, but inspiration goes further. There is no formula or technique that makes us work mathematically when we face a new project. We are lucky to have a good capacity of understanding that helps us unlock an idea through reflection or coherence. Over time, we have learned to be more efficient in order to achieve the goal in the best possible way.

Cosa ispira il vostro lavoro?

Una mostra, una canzone, un libro o un viaggio, la luce, la tranquillità, il mantenere la mente sveglia... tutto questo funziona per noi, ma l'ispirazione va oltre. Non esiste una formula o una tecnica che ci faccia lavorare matematicamente quando affrontiamo un nuovo progetto. Siamo fortunati ad avere una buona capacità di comprensione, che ci aiuta a sbloccare un'idea attraverso la riflessione o la coerenza. Nel tempo abbiamo imparato ad essere più efficienti per raggiungere così l'obiettivo nel miglior modo possibile.

ACTUCC30XXLA1ER + ACDISTSXORXXR + ACTUXX30XXB2ER + ACDISTBIFORXXR + ACTUCX30XXB2ER + ACDISTSXORXXR + ACTUXC30XXLA1ER + ACCAVOEL4X001NE + CANOPY + DRIVER

# Horizontal suspension composition examples

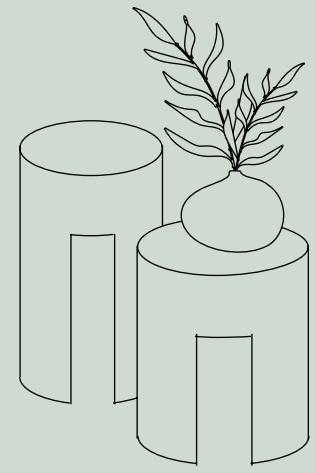
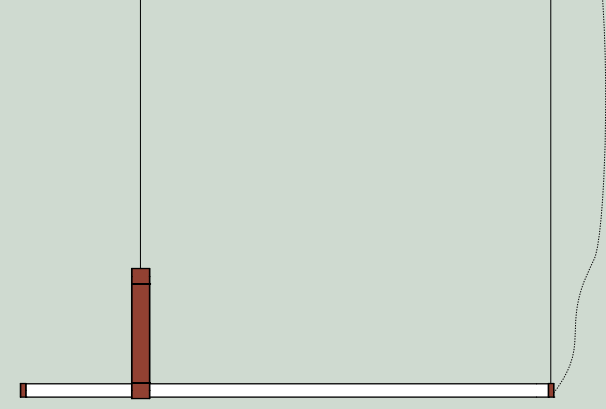

FIG. 1

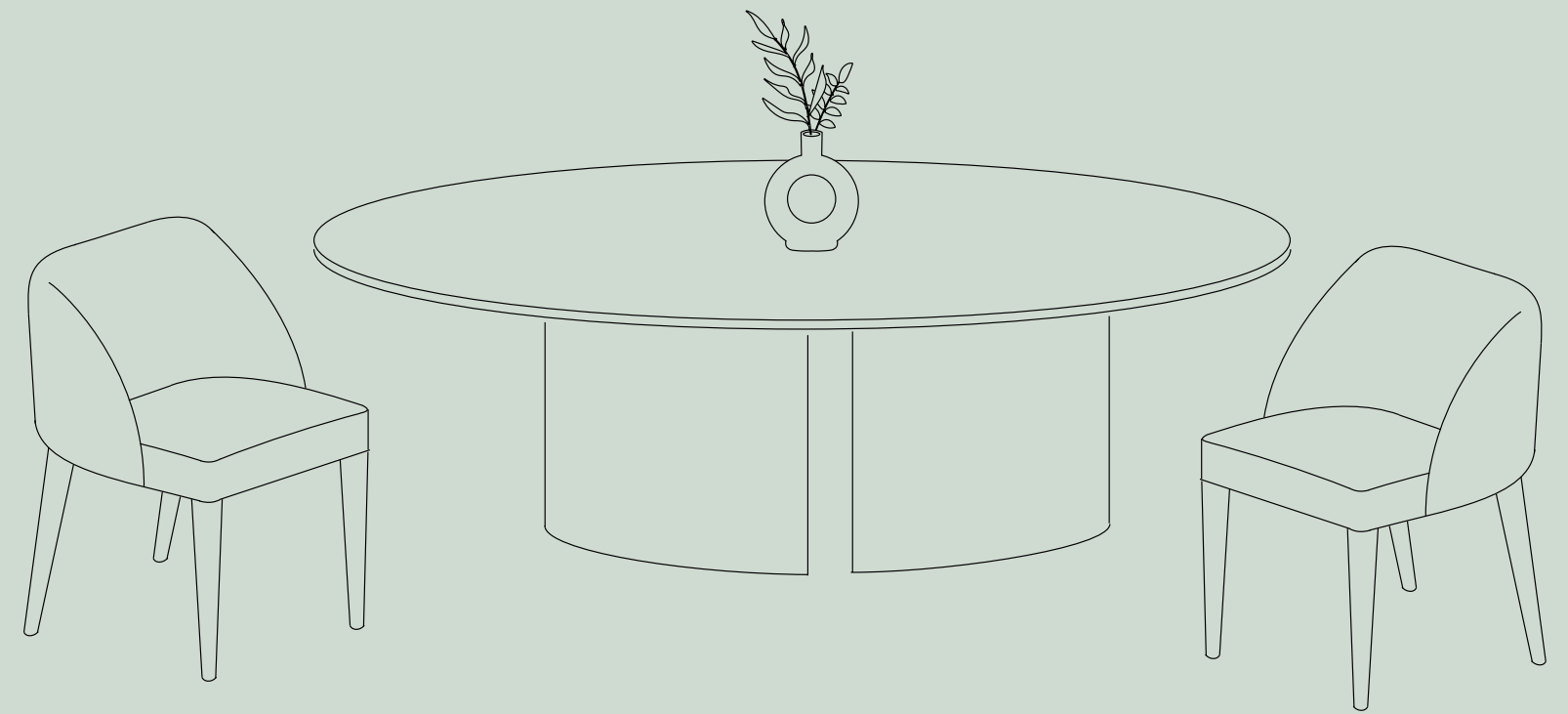
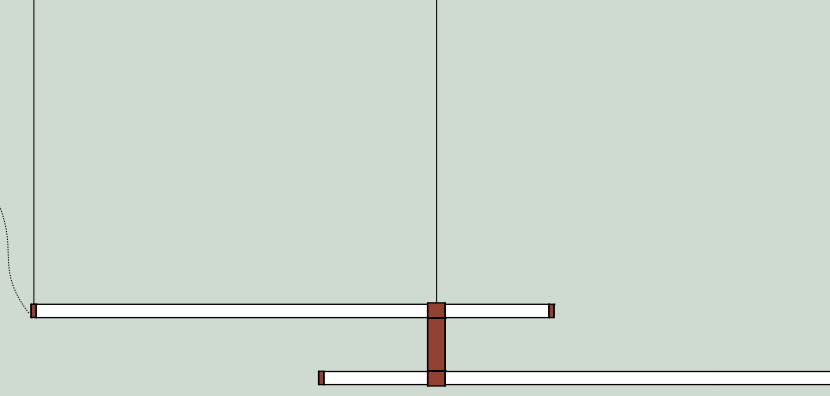

FIG. 3

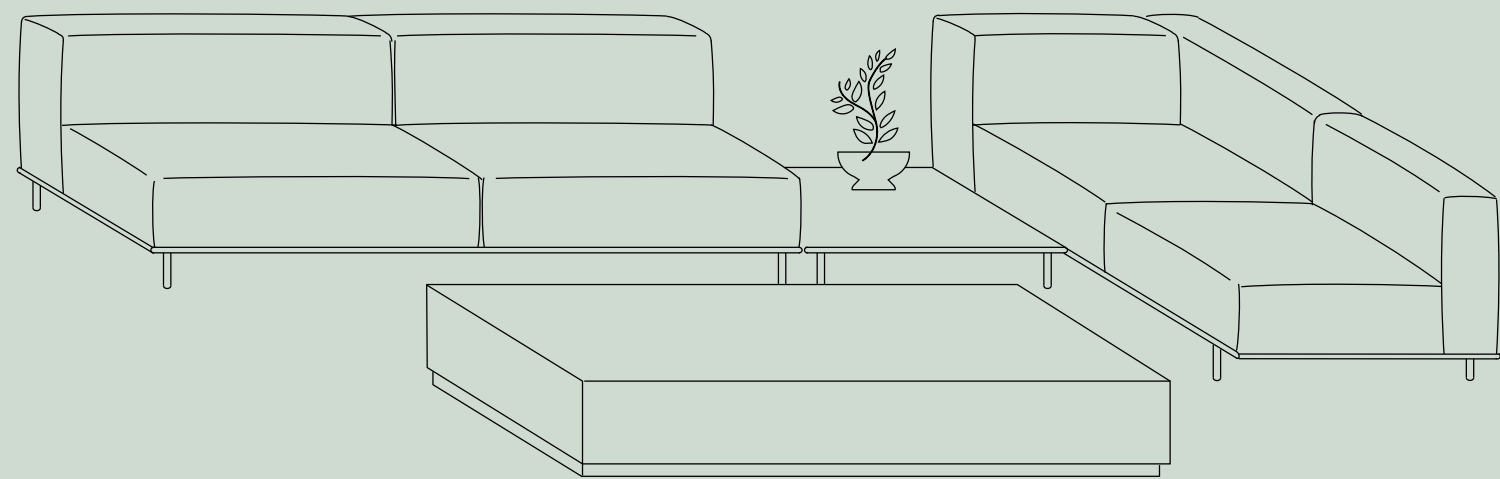
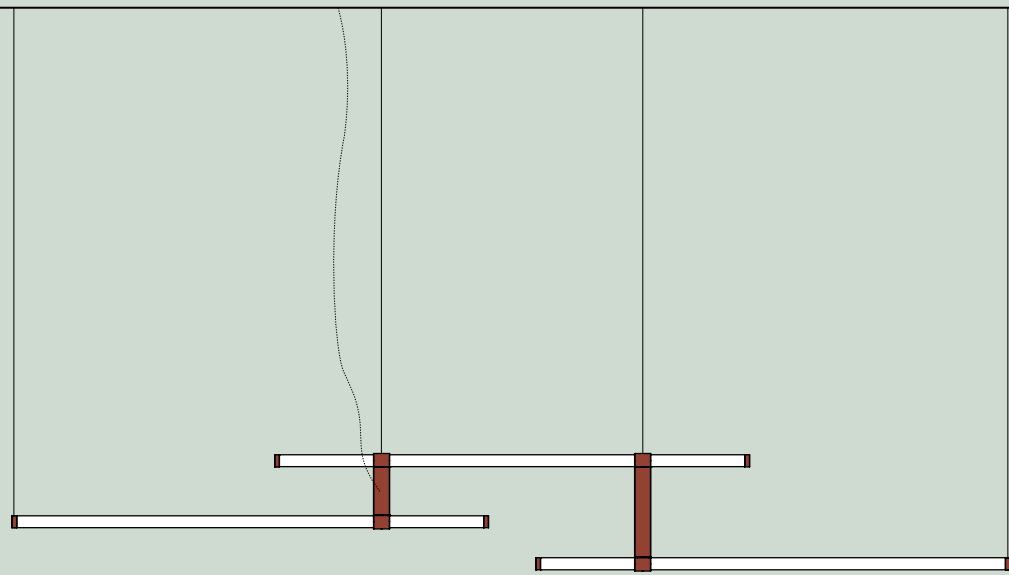

FIG. 2

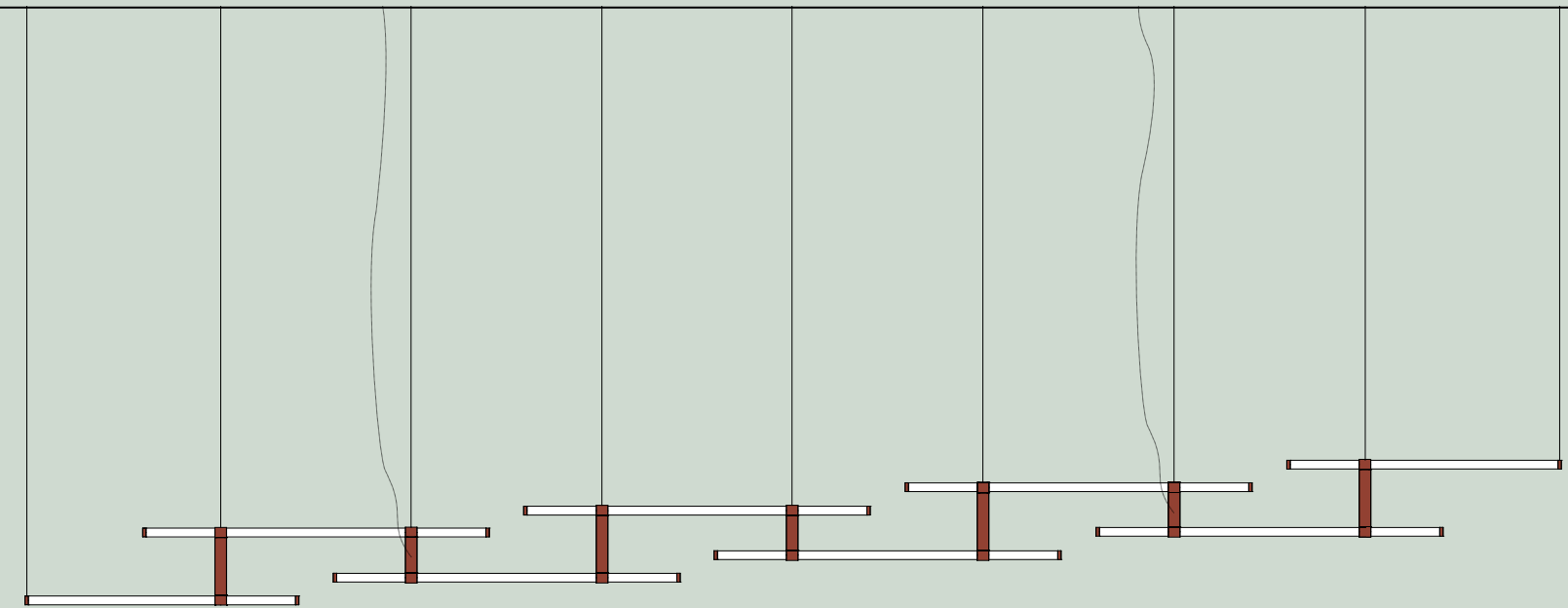

FIG. 4

vertical  
suspension



ACTUXX30EXSMXPG + ACDISTSMXVEXXPG + ACTUXX30EXSMXPG + ACDISTSMXVEXXPG + ACTUXX30EXSMXPG + CANOPY + DRIVER

wall



ACTUXX30XXLAIER + ACDISTSMXAPXXER + ACTUXX30XXLAIER +  
2 X ACSTAFFA001XXER + DRIVER

—○—○—○— paralela



ACTUXX30XXMIIPG + ACDISTMIXAPXXPG +  
ACTUXX30XXMIIPG + DRIVER

# Vertical suspension composition examples

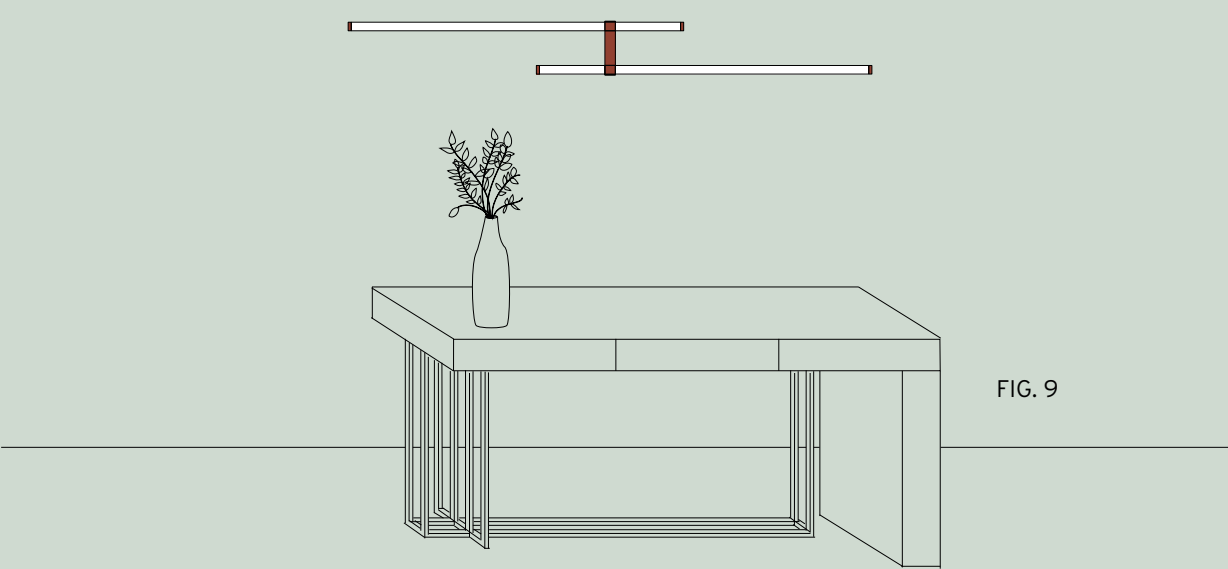
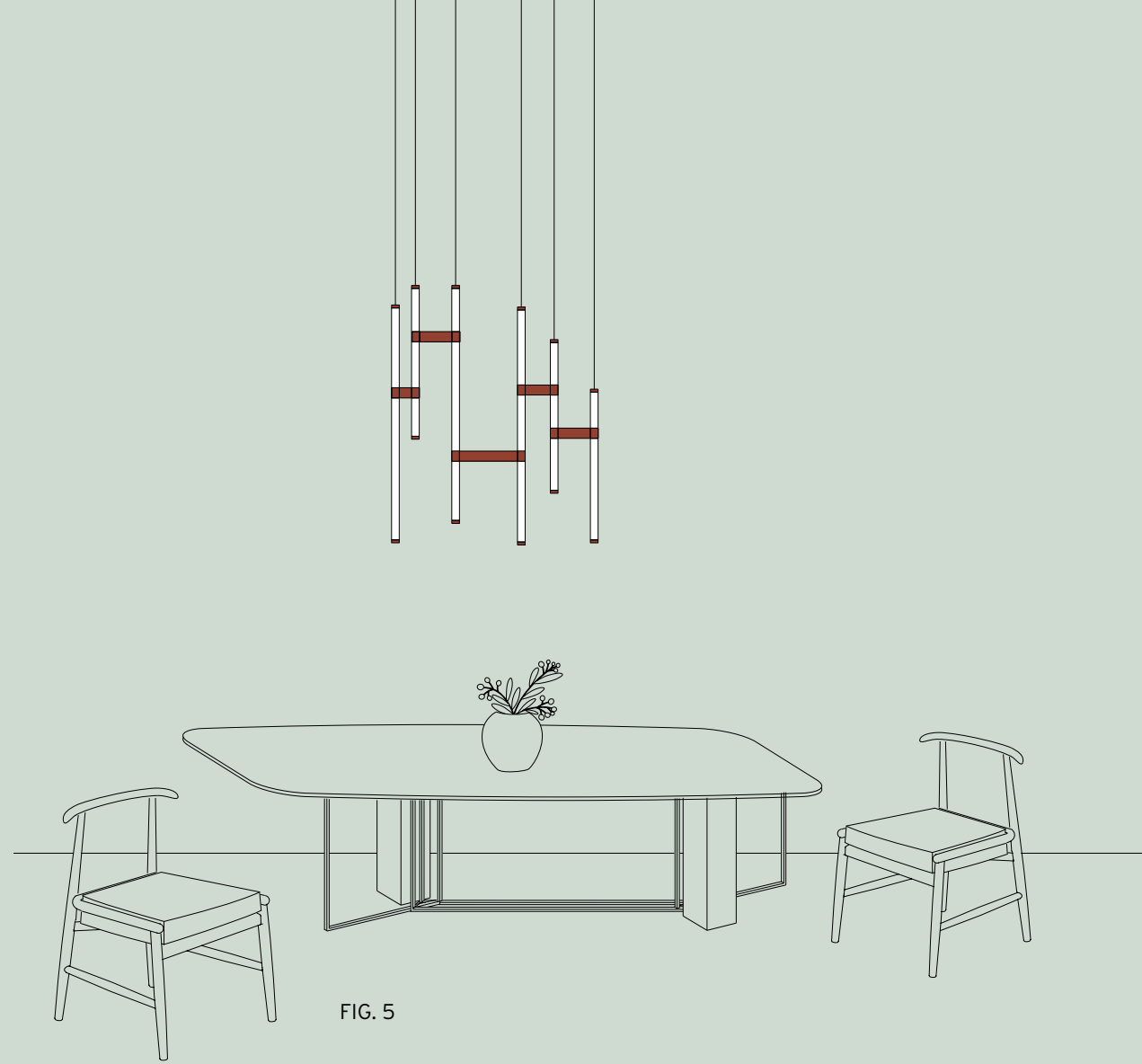

# Wall composition examples

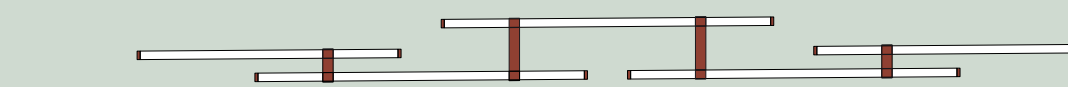
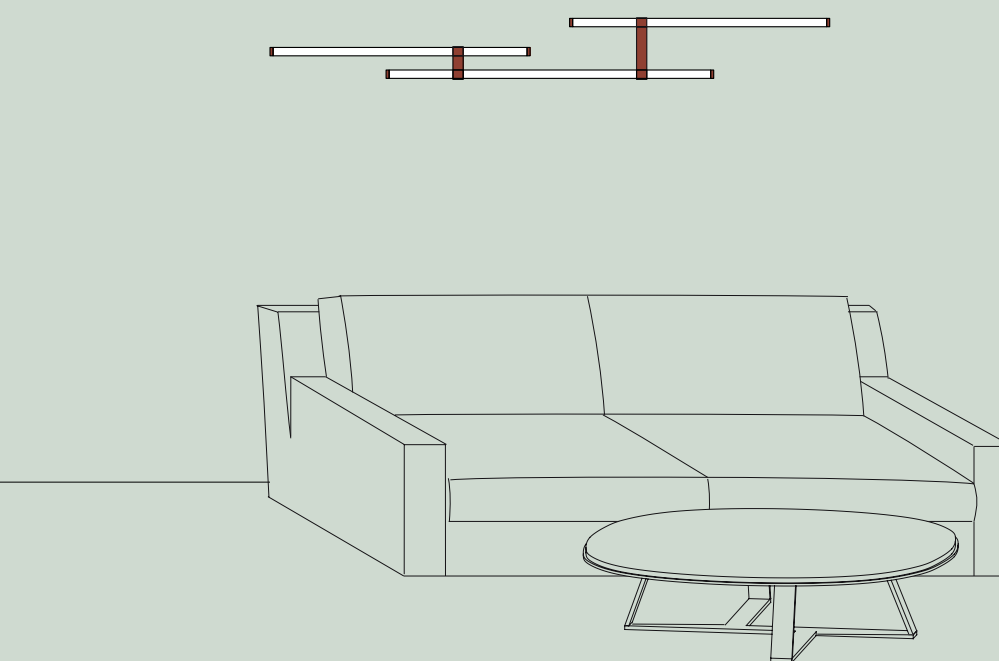
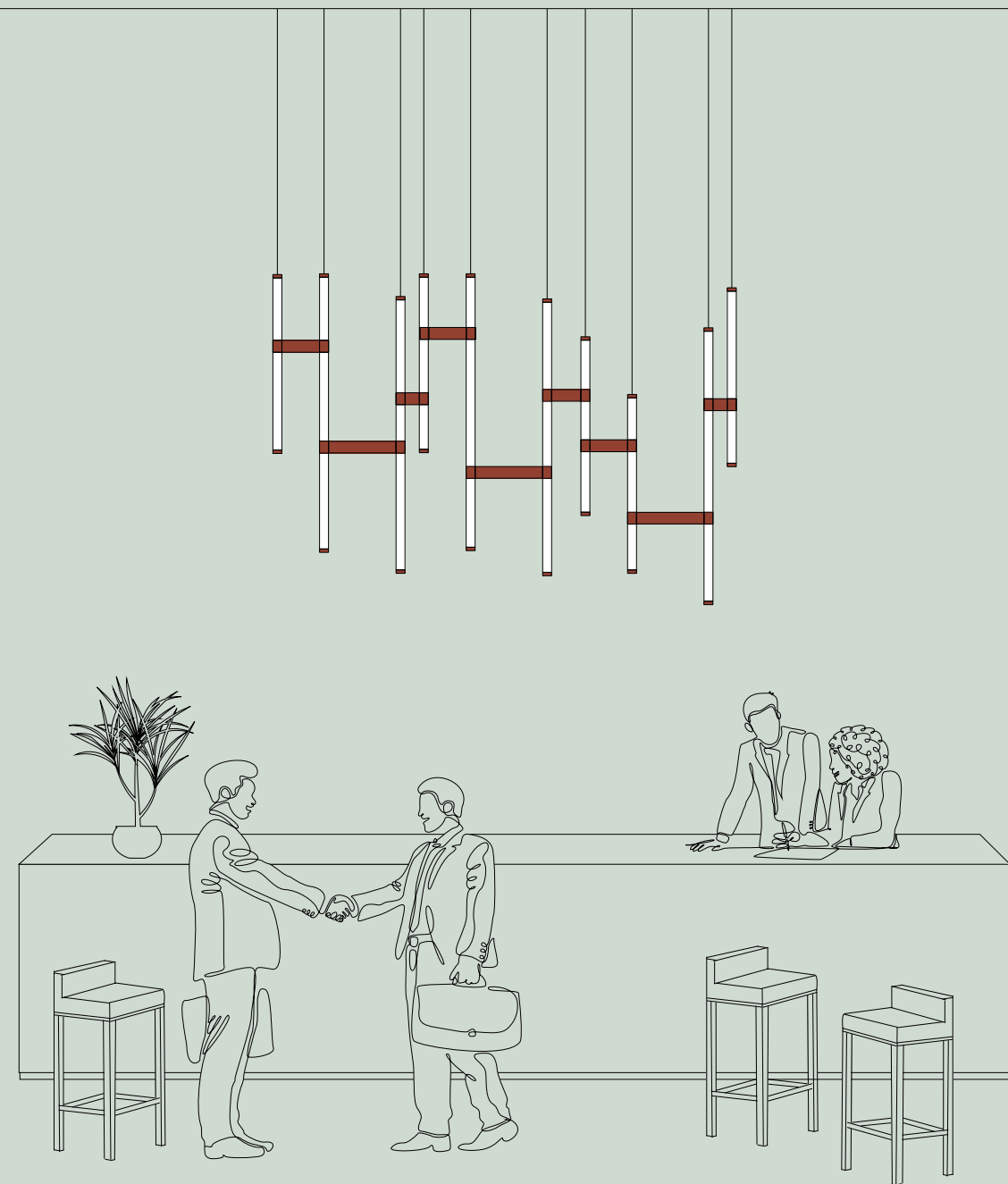
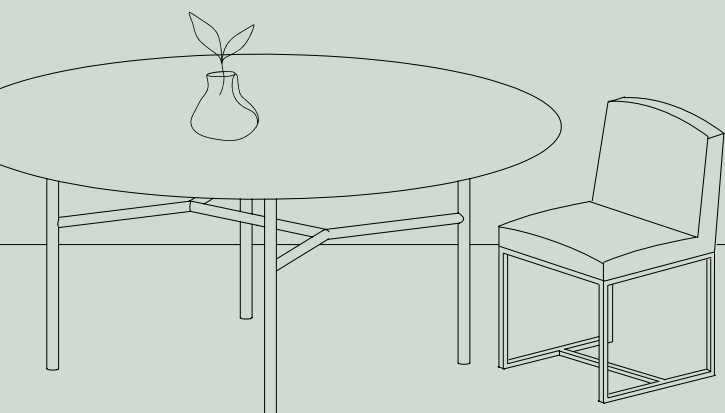
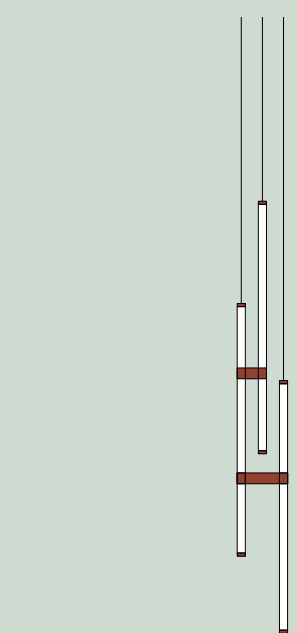
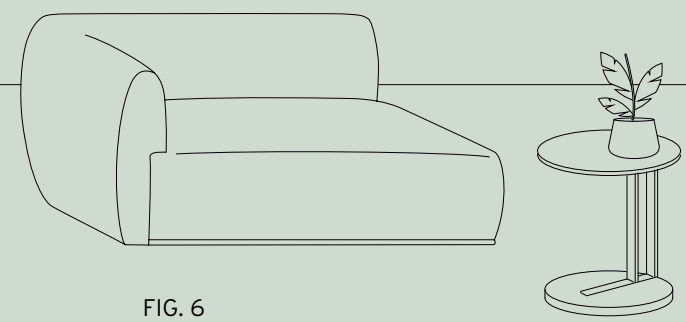
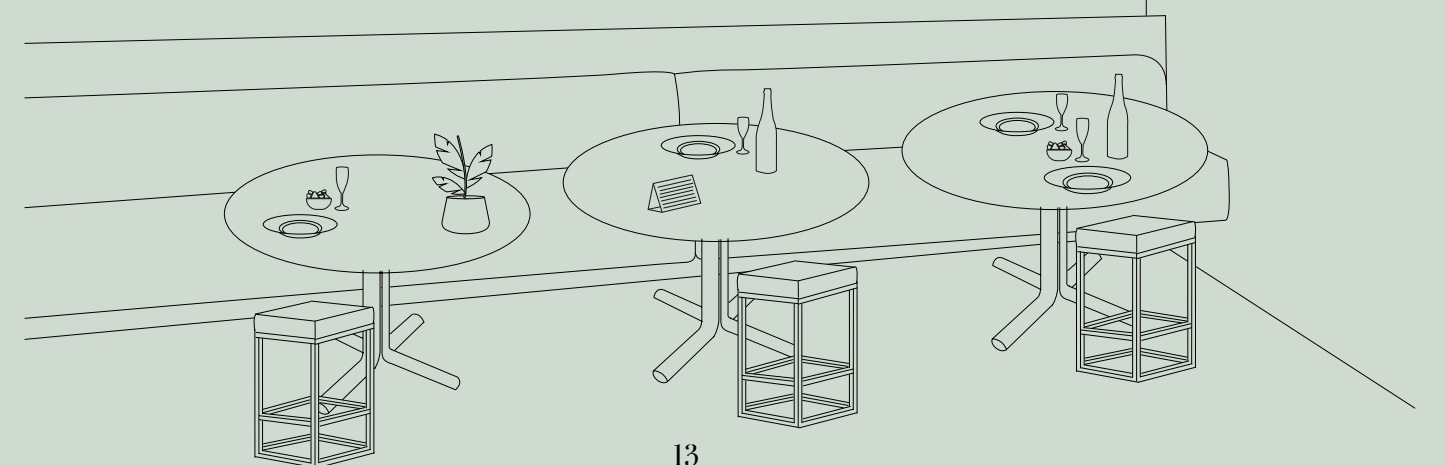

FIG. 12



floor



PTPARALELA30XNE + ACCONTROLPT0001

paralela

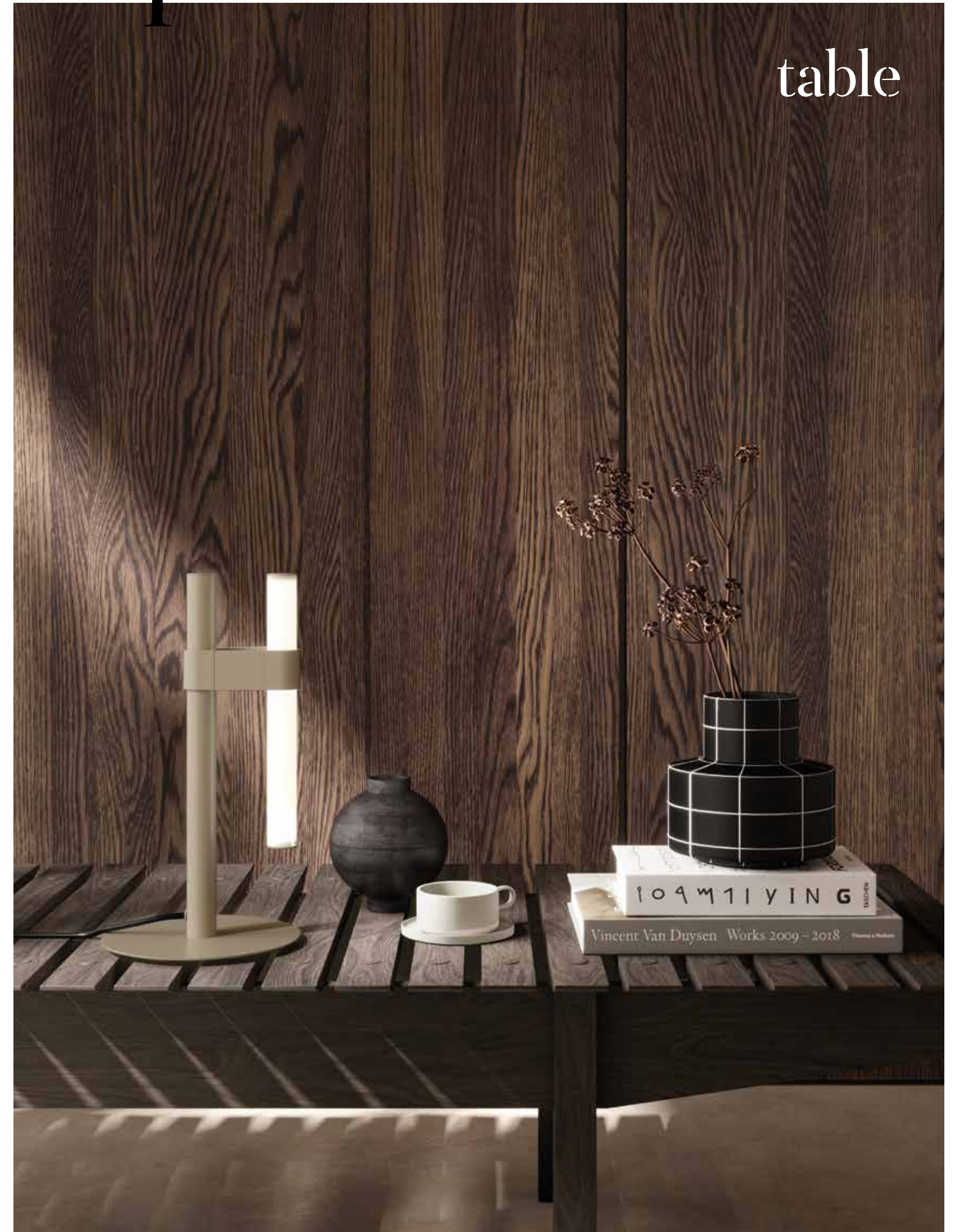

table

LTPARALELA30XGE + ACCONTROLLT0001

# paralela

Collection composed of: modular and multidimensional suspensions, wall and ceiling lamps; floor and table lamps, made of glass.

Collezione composta da lampade in vetro modulari e multidimensionali a sospensione, muro e soffitto; lampade da terra e tavolo.



Main materials: Glass, Nylon PA12  
 IP: 20 | LED: integrated | Vdc: 24 | CRI: >90 | CCT options: 3000K; 2700K  
 Dimming control options: 1-10 V; Dali | Casambi compatible (upon request)  
 LED driver location: canopy for suspensions;  
 remote for suspensions and wall; plug for table and floor lamps

## SYSTEM ELEMENTS (without driver)

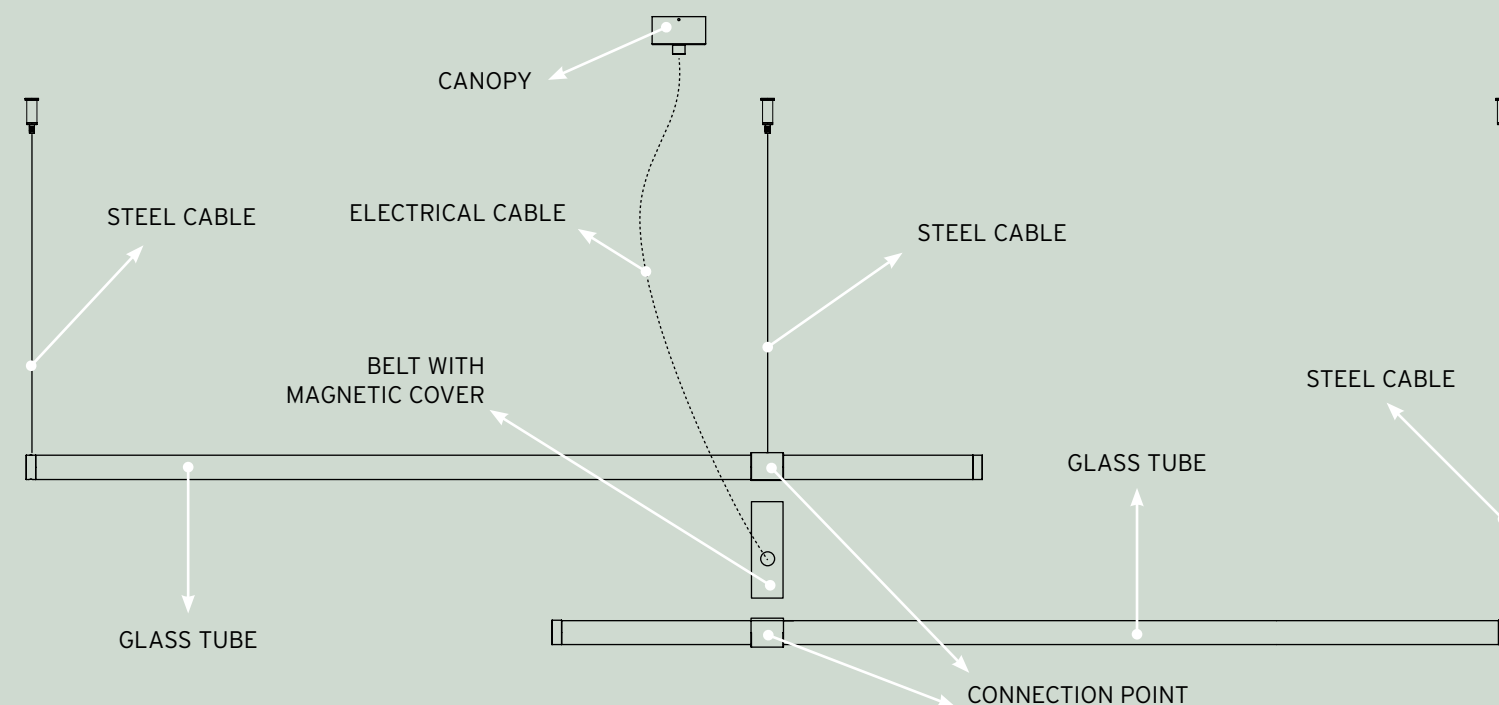

## HORIZONTAL SUSPENSION

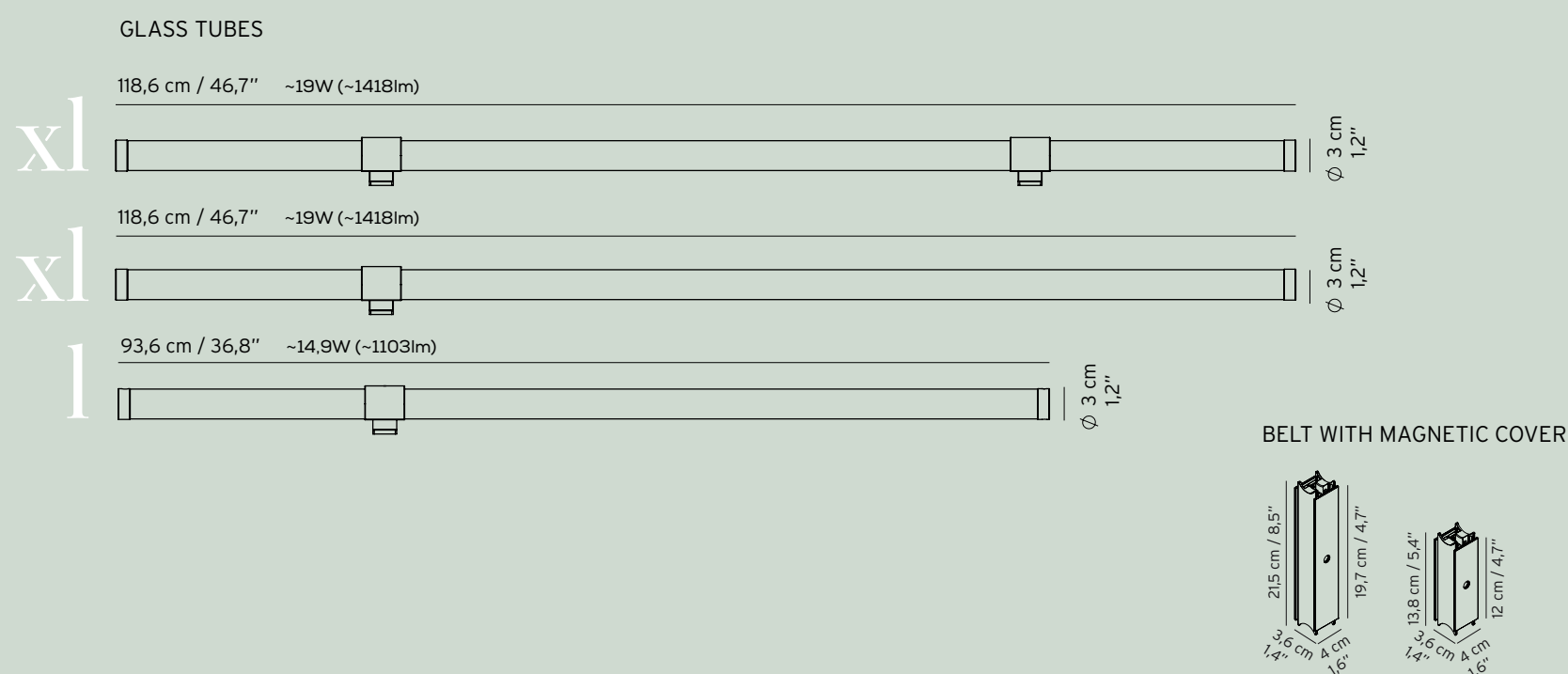

## VERTICAL SUSPENSION

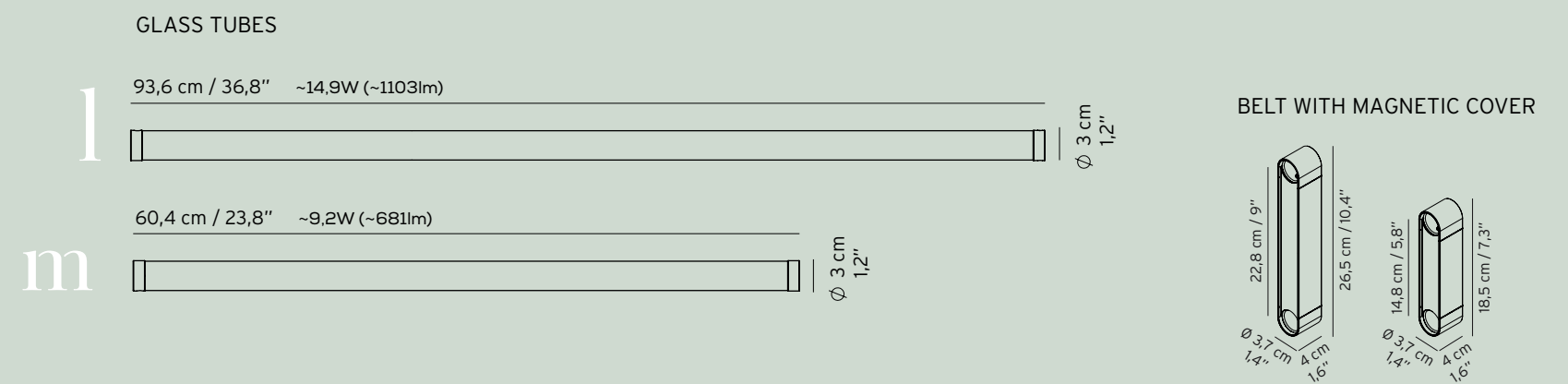

## WALL

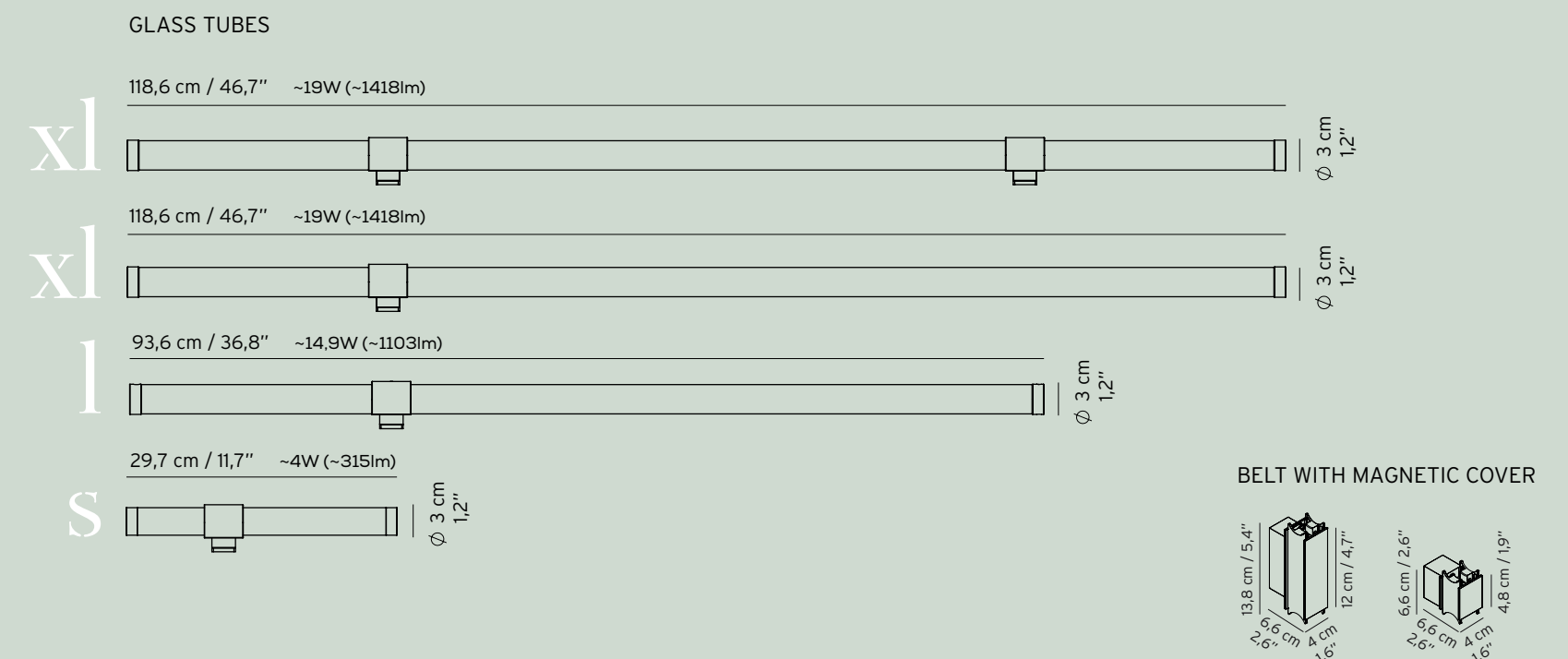

## FLOOR

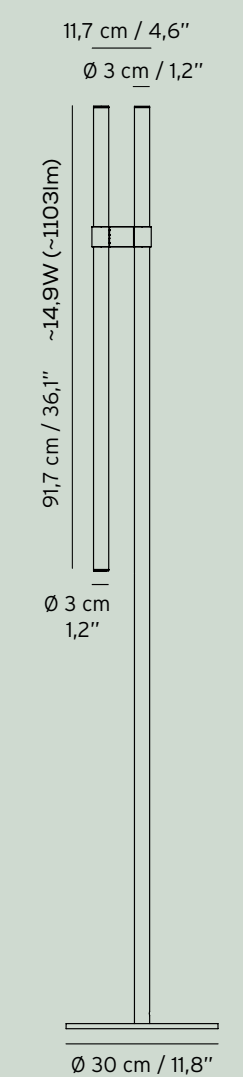

## TABLE

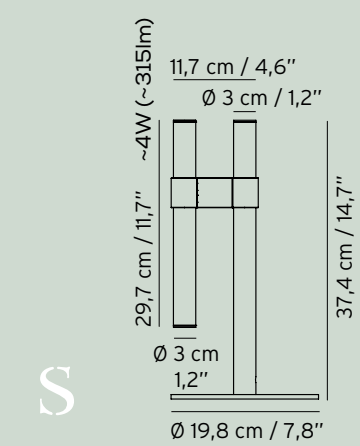

## POWER AND CONTROL EQUIPMENT

Power and control equipment (dimmer, driver, cables, plug)  
 Plugs: EU, USA (Japan), UK, CCC  
 Color: black

